

RFWIZ.com

TSD-4000 Series Digital/Analog Radios User's Manual



Display

TSD-4424 (UHF)

TSD-4124 (VHF)



Non-Display

TSD-4416 (UHF)

TSD-4116 (VHF)

maxon[®]
Maxon America, Inc.

11535 W. 83rd Terrace, Lenexa, KS 66214
Toll-Free: 800-456-2071 (US Only), 913-859-9515
Website: www.maxonamerica.com

Table of Contents

1. Specs & Features	-----	3
2. In-Box Contents & Series Accessories	-----	4
3. Appearance of TSD-4424/4124 Series	-----	5
4. Appearance of TSD-4416/4116 Series	-----	6
5. Accessories and Charging	-----	7
6. Basic Operating Instructions for TSD-4424/4124 Series	-----	10
7. Basic Operating Instructions for TSD-4416/4116 Series	-----	16
8. Precautions and Warranty Statement	-----	17

Thank you for your purchase of the TSD-4000 Series radio.

1. Before using the radio, please read the user guide in detail.
2. The functions and specifications are subject to change without notice.

Specifications

TSD-4000 Series Radio Specifications

Frequency Range	TSD-4124/4116: 136 ~ 174 MHz TSD-4424/4416: 400 ~ 470 MHz
Digital	DMR Tier II TDMA
Programmable Channels	512 Channels: 16 Channels with 32 Zones per channel
Dimensions (H/W/D)	4.6 x 2.16 x 1.33" (118x55x34 mm)
Weight w/battery	234g
Power Source	DC +7.4V Li-ion 2,600mAh Battery
Sensitivity	0.25 μ V 12 dB SINAD (Analog) 0.22 μ V/BER 5% (Digital)
RF Power Output	5/1 Watt (UHF & VHF)
Audio Power Output	1 Watt
Frequency Stability	\pm 1.0 PPM (-30° to +60° C)
Channel Spacing	25/20/12.5 kHz (Analog) 12.5 kHz (Digital) 2 Time Slots of 6.25 Each
Digital Vocoder	AMBE3000 Vocoder Chip with AMBE+2 Voice Compression Algorithm
Dust and Water Protection	IP-54
U.S. Military Standard	MIL-STD 810F/G
Operating Temperature	-30°C to +60°F
Storage Temperature	-40°C to +85°F

Features

- AES Encryption (128, 192, 256)
- Channel Tri-Mode (Digital, Analog, Mixed): compatible with the prevalent analog system, ensuring a smooth analog-to-digital transition. Mixed mode allows your digital radio to receive current analog radios yet transmit digitally to other DMR radios.
- Long Battery Life: 17 hours (Analog) / 23 hours (Digital) on 90/5/5 duty cycle
- Remote Stun / Revive
- Remote Monitoring
- CTCSS / DCS
- VOX

2. In-Box Contents (Subject to change at buyer's request)



Figure 2-1) TSD-4000 Series in-box items

Accessory Part Numbers:

ACC-440N: Radio Programming Software
 ACC-3320E: Programming Cable (USB)
 TSA-4260: 2,600mAH Li-ion battery pack
 TSA-0400: Dual Slot Charger
 TSA-041: VHF "Digital" antenna 6"
 TSA-042: UHF "Digital" antenna 5¼"
 TA-836X: Standard Speaker Microphone
 TA-850X: Heavy Duty Speaker Microphone

TA-855X: Heavy Duty Speaker Microphone
 w/volume control
 TA-817X: "D" Style earpiece w/PTT
 TA-818X: "Discrete" Style earpiece w/PTT
 TA-819X: "C" Style earpiece w/PTT
 TA-50LC/80LC (Display): Leather Carry Case
 TA-50NC/80NC (Display): Nylon Carry Case
 TSA-40BC: Spring Loaded Belt Clip

3. Controls and Appearance of TSD-4424/4124

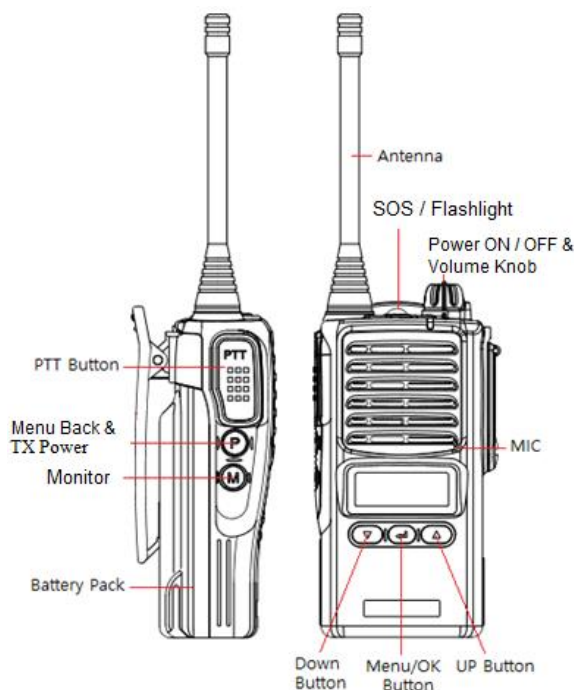

Power ON/OFF Volume Control Knob

Turns radio on/off and adjusts audio volume level.

PTT Button (Push-To-Talk Button)

Press and hold the PTT button to transmit voice and then release it to receive.

Menu/OK/Select (programmable button)

Used to make selections or enter menus. Long press the button to get back to idle screen.

Menu Back/Power (programmable button)

Short press of the button will move you back one step in a menu. Long press will toggle Tx power Hi / Lo.

Monitor Button

Default function of this button is to “Monitor” the open channel. This button can be re-assigned through radio programming.

Up/Down (programmable button)

Operates both as normal channel UP/DOWN button when not in a menu and also as an UP/DOWN selector when in a menu.

(SOS) Emergency Button & Flashlight

Short press will set off an emergency tone. Long press of this button turns on/off the flashlight.

Status LED

This LED is a lamp indicating the current status of the Radio and please refer to the below contents.

- ① RX : Green Lamp
- ② TX : Red Lamp
- ③ CTCSS, DCS Error : Green Lamp blinks
- ④ Low Battery: Red Lamp blinks with “beep” sound.

Speaker/MIC Jack

The accessory connector is used to connect an external speaker microphone or headset. Keep cover closed when not using accessories.

MIC

Please talk 2” from the mic hole for optimum clarity.

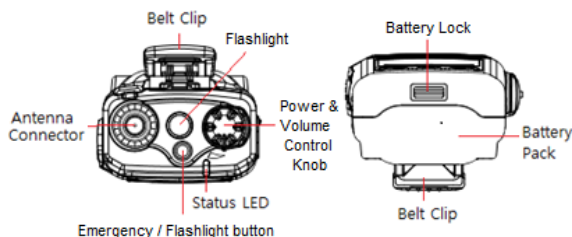
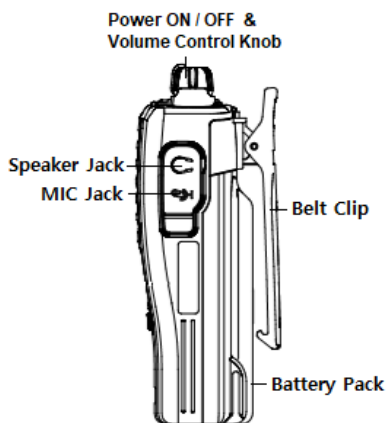

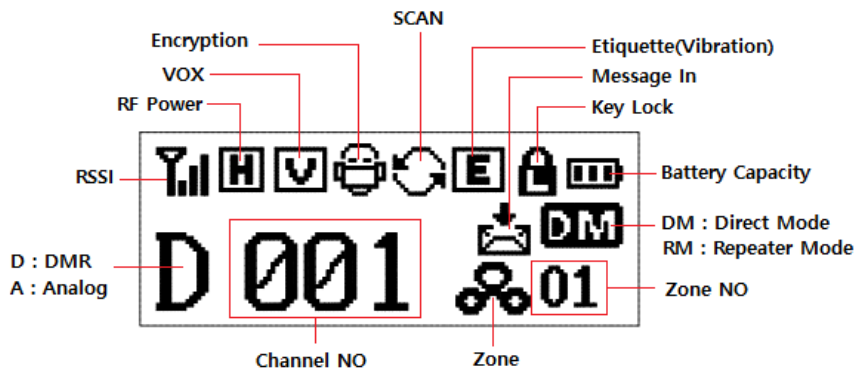
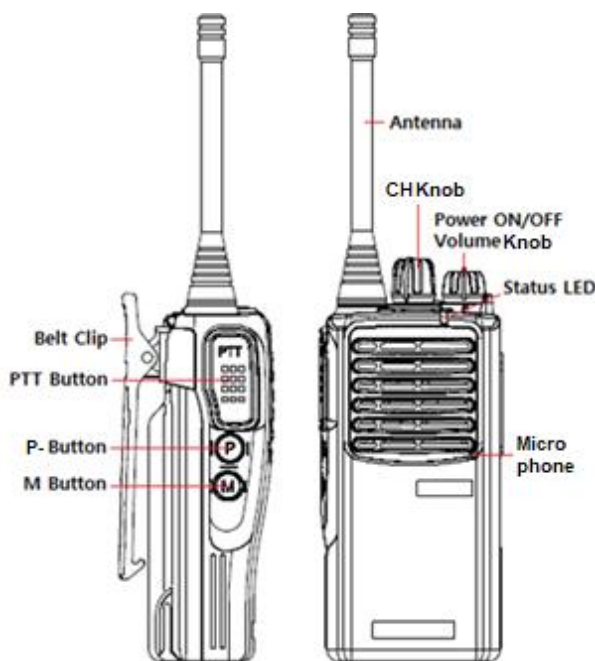

Figure 3-1) LCD Icons for TSD-4424/4124 DMR Radio

3.1 Controls and Appearance of TSD-4416/4116



Power ON/OFF Volume Knob

Turns radio on/off and adjusts audio volume level.

Channel Knob

Change channels by turning the control knob clock-wise or counter-clockwise. 16 Channels can be inputted into each zone. A voice response will notify the user when the channel has been changed. If the channel is not assigned, the radio will beep.

PTT Button

Press the PTT button to transmit voice. Release the PTT button to receive voice. It is recommended to talk 2" to 4" away from the microphone.

P Button

Default function of this button is to easily toggle between high transmit power and low transmit power to save battery life. This button can be reassigned through radio programming.

M Button

Default function of this button is to "Monitor" the open channel. This button can be re-assigned through radio programming.

TOP Button (Orange)

Default function of this button is "Emergency / SOS", This button can be assigned a different function through radio programming.

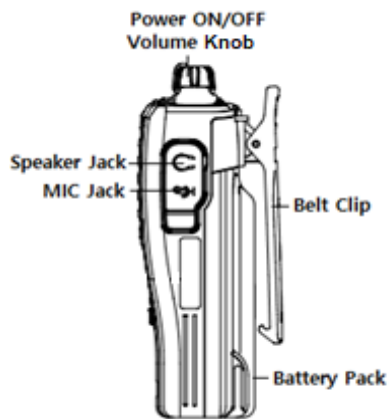

Speaker/MIC Jack

The accessory connector is used to connect an external speaker microphone or headset. Keep cover closed when not using accessories.

Status LED

Used to determine Rx/Tx status and battery charge level.

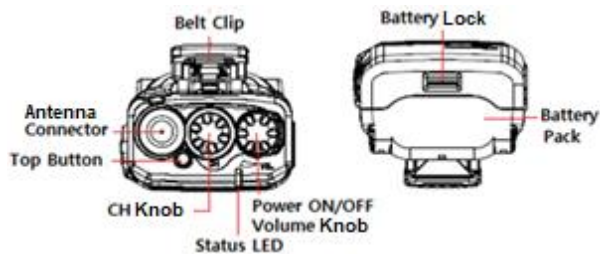

4. TSD-4000 Series: Accessories and Charging

Antenna Attachment and Removal:

Turn the antenna clockwise to put on and tighten the antenna and then counterclockwise to loosen and take off the antenna as shown in diagram on right.

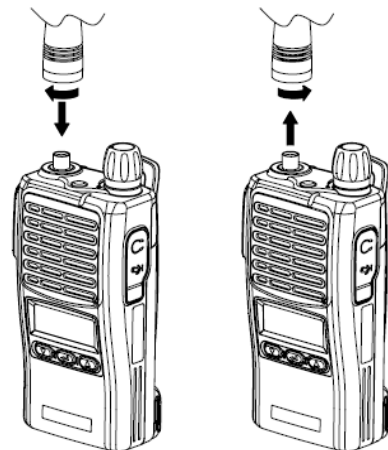

Battery Attachment and Removal:

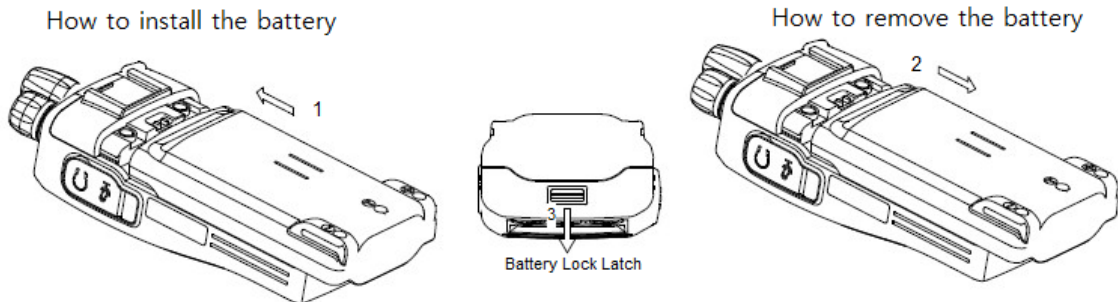

As shown the figure above, to install the battery, align the battery pack with the groove of the back of the radio and push up (in the direction of arrow 1) to attach the battery. Battery latch will click shut when locked.

To remove the battery, pull the battery lock down (in the direction of arrow 3) and slide the battery down and off of the radio.

Belt clip installation: Belt clip attaches to the back of the radio above the battery. To attach the belt clip, align the belt clip to the grooves on the back of the radio as shown the figure 4-2 and push it down (arrow). Clip will “click” when locked.

Belt clip removal: To remove the belt clip, push the belt clip locking tab in (direction 1) & pull the belt clip up (direction 2) at the same time.

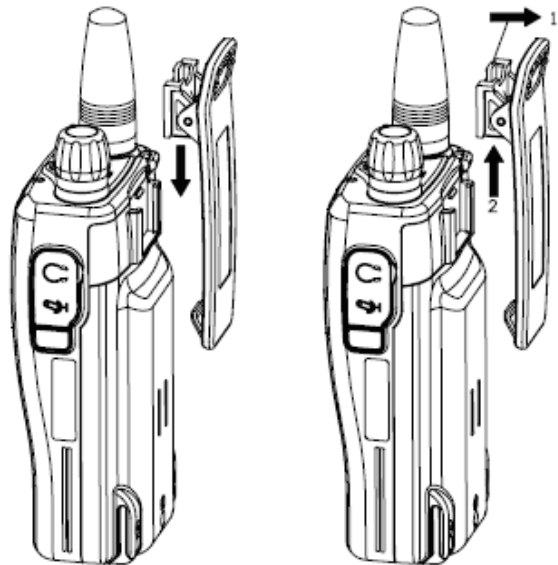

Figure 4-2)

5. Charging the Battery

5.1 Safety Notes

- 1) TSD-4000 Series radios use a large capacity 2600 mAh Li-ion battery (TSA-4260). Use the original battery and charger to ensure you are using safe and reliable equipment.
- 2) Please use a fully charged battery before using the radio for best performance and safety.
- 3) Please turn off the radio first to charge the battery.

5.2 When to Charge Your Battery

When your radio has low battery power, the distance it can communicate becomes shorter, and the

radio performance is degraded. These are the radio's indicators to alert you to a low battery:

- 1) Red lamp on RX/TX LED blinks (every 0.5 second) during transmission or reception, and LOW BATTERY beeping sound occurs during use.
- 2) Battery indicator icon is blinking.

5.3 How to Charge

- 1) Make sure power adapter for the Dual Slot charger is plugged into the charger (Figure 5-1) and then plug the power adapter for the TSA-0400 charger into an AC120V power outlet.
- 2) Turn off the radio before charging.
- 3) Insert radio into the charger's larger, front charging port with the charging contacts on the outside of the radio lined up with the contacts on the charger. LED labeled "F" on the charger will turn on when the connection is made.
- 4) If charging the battery only, line up the outside contacts of the battery with the charging contacts on the 2nd, smaller charging slot in the rear of the dual charger and then insert the battery. LED labeled "R" on the charger will turn on when the connection is made.
- 5) It is recommended to charge another 30 minutes after the LED turns green for a complete charge.

Status	LED indication
Charging	Red LED light
Charging Complete	Green LED light
Error Detected (Battery)	Red LED blinks
Battery in standby	Amber LED light

5.4 Charger (TSA-0400)



Figure 5-1) TSA-0400 and Adapter

6. Using the TSD-4424/4124 Display Series

6.1 Menu description

To enter the Menu mode, press the Menu / Select button. There are 8 main menus in Menu mode when on a Digital Channel and 4 when on an Analog channel. These menus can be added or removed via the radio's PC programmer to help you organize the radio the way you want it. Navigate left or right in this menu and select the menu you wish to go into with the menu button.

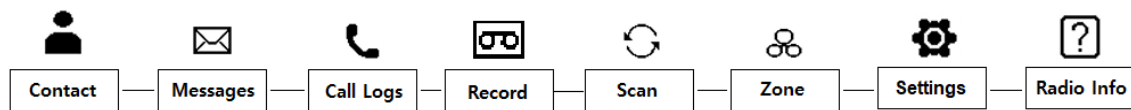

Figure 6-1) TSD-4424/4124 Digital Series Man Menu

Menu options will differ if radio is on a Digital Channel "Digital Mode" Fig 6-2) vs an Analog Channel "Analog Mode" Fig 6-3), see below:

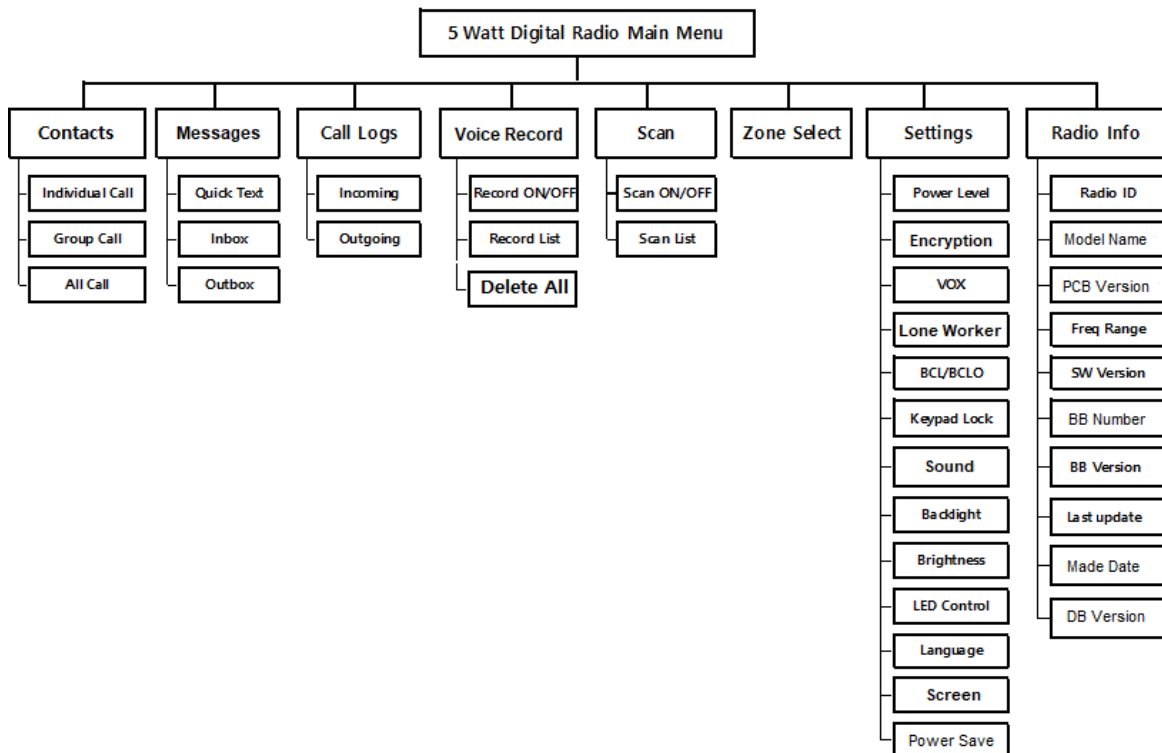

Figure 6-2) TSD-4424/4124 Digital Mode Main Menu tree





Figure 6-3) TSD-4424/4124 Analog Mode Main menu

Note) Radio will revert to standby mode if no selection made in 25 seconds.

6.1.1 Contact (Digital Mode Only)

You can enter your contact list through the settings menu. Radio IDs are set by the radio's PC programmer. Select the radio ID you want to contact and press the PTT button to make a call. Contact lists in the menu can be added, edited, or deleted using the radio's programming software.

The Contact Menu displays "Individual", "Group", and "All Call" contacts using the following icons:

-  : Individual contact list (*individual calls, individual messages can be sent*)
 - **Stun Radio, Revive Radio, Check Radio, & Monitor Radio** *functionality is in this menu. "Stun" will disable the desired radio's ability to Tx. "Revive" will restore the functionality. "Check Radio" checks to see if the target radio in your contact list is receiving. "Monitor Radio" turns on the mic of the target radio to listen to the surrounding sound.*
-  : Group contact list (*group call, group message can be sent*)
-  : All contact lists (*terminals with the same channel and color code are available*)

6.1.2 Messages (Digital Mode Only)

When a new message arrives and the radio is in receive mode, the message contents are displayed on the display and the radio's message menu appears. When a new message arrives during a different radio operation, it will be displayed as a message icon.

The Message menu provides three additional menu functions: Quick Message, Inbox, and Outbox.

1) Quick Message

The radio holds 10 software programmable messages (*each up to 40 characters*) that the radio sends via SMS in digital mode as a "Quick Message". You get into the Quick Message menu using your radio by entering the Main Menu and then select Messages. This will bring you to the Messages menu. Select "Quick Text" to see the available messages to send. Highlight the message you want to send and press the menu button to view the message contents. Press the menu/select button again and highlight the recipient from your contacts list. Press select button to select the recipient and send the message. Press and hold the select button to cancel,

or back up a step by pressing the “P” button.

2) Inbox

The message “Inbox” can hold a maximum of 10 received messages. View your inbox by selecting “Inbox” from your Messages menu and then select the message you want to read from the contents listed. After 10 messages are received in your inbox, the oldest message is overwritten as a new message is received. You cannot delete a received message one at a time. If you want to delete a message, you will need to select “Delete All” from the message menu and delete all the messages in your inbox.

3) Outbox

The message “Outbox” holds a maximum of 10 sent messages. View your outbox by selecting “Outbox” from your Messages menu and then select the message you want to read from the contents listed. After 10 sent messages are stored in your outbox, the oldest message is overwritten as a new message is created. You cannot delete a sent message one at a time. If you want to delete a message, you will need to select “Delete All” from the message menu and delete all the messages in your outbox.

6.1.3 Call Logs (Digital Mode Only)

Call Logs menu stores only the history of your individual calls. Group Calls and All Call radio calls are not saved. The messages are managed by your Message Inbox and Outbox.

1) Inbox

Your radio can store 10 IDs of radios who have called you in your call history Inbox. If more than 10 IDs are received, the oldest IDs are overwritten by the new ones. The Delete menu in your inbox is used to delete your entire call history.

2) Outbox

Your radio can store 10 IDs of radios you have called in your call history Outbox. If more than 10 IDs are stored, the oldest IDs are overwritten by the new ones. The Delete menu in your outbox is used to delete your entire call history.

6.1.4 Voice Record (Digital Mode Only)

You can record your incoming and outgoing radio calls with the “Voice Record” feature located in the Main Menu when on a digital channel. Once it is turned ON, all incoming audio received through the radio and every outgoing audio transmission will be recorded in separate files. Save up to 63, 2-minute transmissions. You have the ability to turn the feature ON or OFF in the Settings menu. If you want to purposely remove a recording, you will need to “Delete All” messages. Numbering

for your oldest recordings start at #1 and are automatically deleted as new recordings are captured.

 <p>Caution</p>	<p>Both the transmitting and receiving radios must either have “Encryption Mode” turned ON or OFF for Voice record calls. Voice record will not record communications between one radio that is using encryption and one that is not.</p>
--	---

6.1.5 Scan (Digital Mode or Analog Mode)

When you turn on the Scan feature for your radio via the Scan menu off of the Main menu, scanning will start in the order of the channels set in the scan list. If there is a radio channel being used during scanning, the radio will stop on that channel and receive its contents. Use the radio programmer to program and select the channel(s) you wish to transmit back on during the scan.

- 1) Scan ON/OFF – Used to turn Scan function ON or OFF in the Menu
- 2) Up to 10 scan lists can be setup using the programmer. Each list is selectable on the radio.

6.1.6 ZONE (Digital Mode or Analog Mode)

Zones are used to organize users within your channels and can be used to expand the number of channels your radio can use. Your TSD-4000 Display series radio has 32 dynamic zones with a maximum channel usage of 512. Contact your radio dealer to program your radio's zones.

6.1.7 Settings

Radio Settings from the Main menu: Power Level (Tx), Voice Encryption, VOX, Lone Worker, BCL / BCLO, Keypad Lock, Sound, Backlight, Brightness, LED settings, Language, Screen, Power Save.

1. Power Level

This setting gives you the ability to toggle your transmission power between High and Low. High Power gives your radio a farther transmission range, but can drain your battery quicker. Low Power saves battery life, but will shorten your transmission range.

2. Encryption (Digital Mode only)

Your radio's Voice Encryption feature is used to encrypt incoming and outgoing voice communications. Menu setting on radio turns encryption ON or OFF. Encryption settings are adjustable using your radio dealer's programming software. Encryption can be set for each digital channel. Key length is up to 256 and key itself is created automatically according to key length.

3. Squelch (Analog Only)

Suppresses channel noise when the radio is not receiving a transmission.

4. VOX

VOX function allows you to initiate a hand's free voice-activated call through your radio when you switch to a programmed channel or select it from the menu. The radio detects your voice and automatically transmits without using the PTT button. The VOX feature's sensitivity level is adjustable by the radio's programming software with level 5 being the least sensitive and 1 being the most sensitive.

5. Lone Worker (Digital Mode Only)

When turned on, the "Lone Worker" feature will automatically send out an emergency call to the rest of your fleet through your radio when there is no radio activity within the time set in the menu. To activate, select the time after you enter the Lone Worker menu by pressing the up button. Each press will increment one minute. Choose between 1-100 minutes then press the select button to make the selection. "Set Success" will appear on the screen when activated.

6. BCL/BCLO

The BCL/BCLO function is used to prevent the radio from transmitting while the channel is busy to avoid interruption of a conversation in progress. The default setting is OFF.

BCL (Busy Channel Lockout): Prohibits transmission on the same RF frequency.

BCLO (Busy Channel Lockout Override): Allows transmit only if the CTCSS/DCS or Color Code match.

7. Keypad Lock

Keypad lock is used to lock the keypad from accidental keypresses. When the keypad lock function is on, all buttons are locked except the PTT button, the emergency button and power ON / OFF switch. If turned on from the Main Menu, the "Key Lock" feature is activated when there is no input information for 5-20 seconds (*programmable through settings menu*). To turn off "Key Lock", long-press the P1 key to turn off the feature and use all the keys.

8. Tones

Allows you to turn on or off all tones in the radio.

9. Backlight

"On" keeps the radio's backlight on indefinitely. "Timed" turns the backlight OFF after a period of time set by your radio's programmer.

10. Brightness

Used to adjust the screen brightness from 1 (dim) to 7 (brightest)

11. LED Control

Used to turn your LED status display ON or OFF. Your radio dealer can adjust detailed LED status behavior using the radio's programming software.

12. Language

Used to select the language for the radio's menus. Korean or English.

13. Screen

Used to select between 3 different screen modes (see fig 5-1).

Channel Numbers	Screen 1	Screen 2	Screen 3
1	D001	01 D001 DMRDigiCh1	001D
2	A001	01 A001 Analog Ch1	002A

KEY

D = Digital
A = Analog
"1" First analog and digital channels

KEY

01 = Zone
D001 same as Screen 1
Alias channel name

KEY

001D First channel in the Zone.
D = Digital
A = Analog

Figure 5-1) Description of Display screen selections

14. Power Save

Radio goes into power save mode until radio is activated. You can select ratio on time radio checks for activity. Power save consists of 4 steps: ① OFF ② 1: 1 ③ 1: 2 ④ 1: 4.

6.1.8 Radio information





Used to show the radio's information: Radio ID, Model Name, PCB Version, Freq Range, SW Version, BB Number, BB Version Last SW Update, Made Date, DB Version. Press the "Select" button to make a selection in this menu.

7. TSD-4416/4116 (Non-Display) Function and Operation

Function	Button & Setting	Status LED	Descriptions
Power ON/OFF	ON/OFF/Volume Control Knob	Orange	Power up chime is heard then current radio channel selected will be spoken. If radio is on an unprogrammed channel, radio will beep. LED will be orange during power up.
Transmit (TX)	PTT Button	High Power: Red Low Power: Orange	Press and HOLD PTT to talk, release to listen. Other buttons can be programmed with the PTT function through your dealer's software.
Receive (RX)		Green	Steady green for decode. If channel is busy, the LED blinks.
Channel Change	Channel knob	Flashes Orange during channel switch	Turn the channel knob to the channel you want. Voice will state what channel you are on. If channel is not programmed, radio will beep.
Adjust TX Output Power	(P) Button *Programmable Button	Orange	You can toggle between High Transmit (TX) power and Low TX power by pressing the "P" Button. Voice announcement will indicate High or Low Power setting.
Monitor	(M) Button *Programmable Button	Green w/ Voice notification	User can check whether the Receive Transmission (RX) of current channel is OK or Not. Press and release the (M) button to open the squelch on an analog channel.
Emergency	Orange button on top. *Programmable Button		In an emergency, press the orange colored Emergency button for 3 seconds to activate a siren & transmit an emergency call to your party.
Switch Zone	PC programmable function	Voice notification	Allows you to change the calling area to use more channels
VOX	PC programmable function	Voice notification	Used for transmitting voice without pressing the PTT Button
SCAN	PC programmable function	Voice notification	Scan button initiates the scan of each channel in the scan list for activity. If channel is busy, the radio stops scan and received audio is heard. Scan resumes when hang timer expires. Normal & Priority Scan are available.
Stun/Revive	PC programmable function	Voice notification	Used to disable and then revive radio remotely via another radio
Encryption (Digital Channel Only)	PC programmable function	Voice notification	Uses AES Encryption (128, 256) to scramble & unscramble voice transmissions for privacy.
Remote Monitor	PC programmable function	No indication on target radio	Turns on radio's microphone to monitor any audible activity surrounding the target radio.
Remote Check	PC programmable function	Voice notification	Checks whether target radio in your contact list is receiving.
Talkaround / Repeater	PC programmable function	Voice notification	Switches the current channel from repeater mode to talk-around mode and visa-versa.
Keypad Lock/Unlock	PC programmable function	Voice notification	Locks and unlocks the keypad. This feature prevents accidental key presses



8. Precautions

8.1 Precautions for Safe Operation of this equipment.

 <p>WARNING</p>	<p>Don't remove the antenna from the Radio and don't transform the antenna or make any changes to the antenna. Strong electronic waves emitted from the Radio can have an effect on the performance of the Radio if the antenna is modified and can cause the Radio to have a defect not covered under warranty.</p>
 <p>Caution</p>	<p>Don't use other manufacturer's accessories (such as rechargeable battery, Adapter, external speaker microphone and earphone, etc.). Unknown or unauthorized accessories may damage the radio and void the warranty.</p>
 <p>WARNING</p>	<p>Don't disassemble or reorganize the Radio. The disassembly or reorganization of your radio is punishable by law and can cause damage to the radio that will not be covered by the warranty</p>
 <p>WARNING</p>	<p>Don't use frequencies you do not have a permit for.</p>
 <p>Caution</p>	<p>Avoid excessive shock to the Radio. Don't place the Radio where the direct sunlight and/or the high temperature occurs, battery damage can occur in this environment. Do not disassemble or damage the battery pack.</p>

8.2 Do not use the radio where prohibited.

Your radio emits a strong electronic wave which may have an effect on the operation of other equipment and can also be affected by those other devices.

 <p>WARNING</p>	<p>Please turn off the Radio before boarding on airplane. If you want to use the Radio in the airplane, please follow the rules in the airplane or the instructions by crew.</p>
 <p>WARNING</p>	<p>If using radio in an area where medical equipment is being used, please get permission from the related doctor to prevent interference issues.</p>
 <p>Caution</p>	<p>Be careful when using your radio in a place where computers or other electronic devices are being used because the strong electronic waves from the Radio can affect this equipment.</p>

8.3 Safety Notes

Please read the following recommendations for safe and effective use of the Radio.

 <p>WARNING</p>	<ul style="list-style-type: none">• Please keep the Radio away at least 1 inch from the body.• Do not touch antenna if it is damaged. Risk of skin burn can occur if the outside surface of antenna gets stripped out.• Please be careful when putting the battery in a pocket or a bag. If you contact a conductive metal to a battery terminal, there is a heat and fire risk to your radio.• Please don't listen to the radio at a high-volume level when using earphones. Loud volume may have a lasting bad effect on your hearing.• It is recommended to adjust the volume step by step to the level you want after you set the radio volume of the radio at a low level.• Please don't remove or replace or charge or discharge the battery in an hazard area where sparks could cause an electrical fire.• Turn off the radio in areas where there is a strong electromagnetic force.
---	---

FCC RF EXPOSURE COMPLIANCE REQUIREMENTS FOR OCCUPATIONAL USE ONLY

The Federal Communications Commission (FCC), with its action in General Docket 93-62, November 7, 1997, has adopted a safety standard for human exposure to Radio Frequency (RF) electromagnetic energy emitted by FCC regulated equipment.

Proper operation of this radio will result in user exposure far below the Occupational Safety and Health Act (OSHA) and Federal Communications Commission limits.

- DO NOT transmit for more than 50% of total radio use time (50% duty cycle). Transmitting more than 50% of the time can cause FCC RF exposure compliance requirements to be exceeded.
- This radio is NOT approved for use by the general population in an uncontrolled environment. This radio is restricted to occupational use, work related operations only where radio operator must have the knowledge to control the user's exposure conditions for satisfying the higher exposure limit allowed for occupational use.
- When transmitting, hold the radio in a vertical position with its microphone 1 inches (2.5 cm) away from your mouth.
- The radio is transmitting when the red LED on the front of the radio is illuminated. You can cause the radio to transmit by pressing the PTT bar on the radio.
- These are required operating configurations for meeting FCC RF exposure compliance. Failure to observe these restrictions means violation.

This device complies with part 15 of FCC rules. Operation is subject to the following two conditions:(1)

This device may not cause harmful interference and (2) This device must accept any interference received, including interference that may cause undesired operation.

Warranty Card

Thank you for purchasing a TSD-4000 Series radio.

1. This product has passed strict quality control and testing procedures
2. Warranty is one year from the date of manufacture.
 - Failure of the product under normal operating conditions, during the warranty period may be repaired by Maxon America free of charge.
3. For the following cases, service fees will be charged.
 - When repair occurs after the warranty period has passed.
 - When the product is damaged due to user's mishandling, abuse or improper operation.
 - When the product is damaged due to user's modification, attempted repair or otherwise access to sealed/non-user serviceable items.
 - When the product is damaged due to fire, pollution, earthquakes and any other natural or unnatural conditions, accidents, etc.
4. Personal information for radio:

Model No.	TSD-4000 Series	
Serial No.		
Purchase date		
Purchaser	Name	
	Address	

✘ Please contact Maxon below for Return Merchandise Authorization (RMA) number before you send your radio back for service.

Maxon America

11535 West 83rd Terrace, Lenexa KS 66214

Tel: 800-456-2071

Fax: 913-859-9550

maxon[®]
Maxon America, Inc.

11535 W. 83rd Terrace, Lenexa, KS 66214
Toll-Free: 800-456-2071 (US Only), 913-859-9515
Website: www.maxonamerica.com

* This User manual is subject to change without notice.